

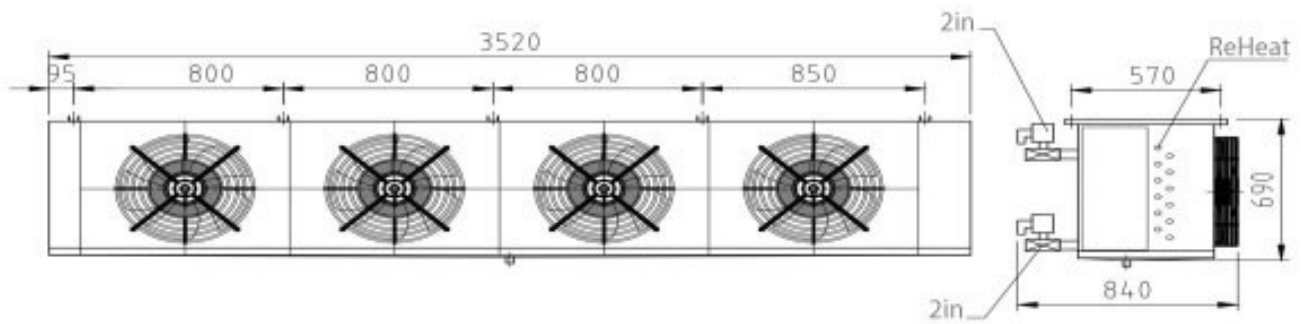

Unit Tag	Qty	Model No	Net Cooling	Nominal Voltage
TCA10TAHURHE	1	TCA10TAHURH	10 (ton)	208-3-60.0

Evaporator Data		Reheat Data		Physical Data	
Surface Area (sqft)	2260.50	Moisture Removal (ppd)	1000.000	Rigging Wt. (lb)	639
LWT (°F)	44.00	Effeciency P/kWH	57.40	Operating Wt. (lb)	641
Fan Data		Testing Conditions		Electrical Data	
Diameter (in)	20	Ambient	80	FLA (amp)	8.9
Qty	4	Humidity (%)	60	MCA (amp)	11
Watts	460				



<https://tricleanair.com/techsheets/>