

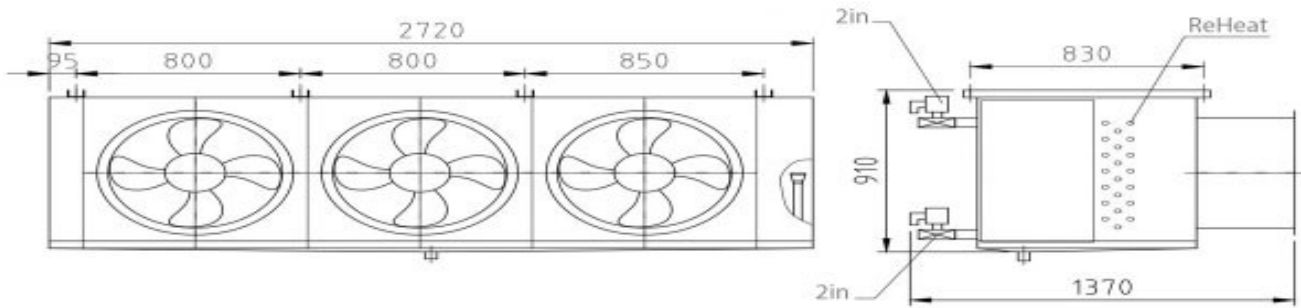

Unit Tag	Qty	Model No	Net Cooling	Nominal Voltage
TCA15TAHURHE	1	TCA15TAHURH	15 (ton)	460-3-60.0

Evaporator Data		Reheat Data		Physical Data	
Surface Area (sqft)	3552.00	Moisture Removal (ppd)	1500.000	Rigging Wt. (lb)	989
LWT (°F)	44.00	Effeciency P/kWH	57.40	Operating Wt. (lb)	994
Fan Data		Testing Conditions		Electrical Data	
Diameter (in)	24	Ambient	80	FLA (amp)	96.5
Qty	3	Humidity (%)	60	MCA (amp)	120.6
Watts	1500				



<https://tricleanair.com/techsheets/>