

OWNER'S MANUAL

COMMERCIAL DEHUMIDIFIER

TCA-320D



HORTICULTURE
CULTIVATION
OPERATION



PRECISE HUMIDITY
CONTROL



HIGH AIR
FLOW



HIGH
CAPACITY

IMPORTANT: After unpacking (or accidental tip-over) allow dehumidifier to stand upright for 1 hour before starting

Directory

IMPORTANT SAFETY INSTRUCTIONS	1
STRUCTURE OF PRODUCT	1-2
INSTALLATION SKETCH	3
CONTROL PANEL	3-4
PROTECTION FUNCTION	5
CAUTION IN USE	6
COMMON FAULTS REMOVING	7
MAINTENANCE OF MACHINE	8
TECHNICAL PARAMETERS	9
PERFORMANCE	10
WHAT IN THE BOX	11

IMPORTANT SAFETY INSTRUCTIONS

Please read all the instructions carefully before using the machine

- Confirm power supply is 220-240V/60Hz
- Do not power on/off the machine by connecting/cutting the power supply
- Do not roll or damage the power cord when install or remove the machine
- Do not put fingers or any other rod like object into the machine
- Remove power cord before cleaning or maintain the machine
- Make sure to connect the ground lead
- Don't do any change of machine unless guiding by our technicians

⚠ Attention: The machine has loss and dislocation phase protector, when the connected three phases outer power supply is not correct as the machine setting, the protector will be disconnected, all the indicator on control panel will be regularly display, but the machine will not run. Please correct the power supply phase connection, and restart the machine at this condition. This operation requires professional electric technicians.

STRUCTURE OF PRODUCT

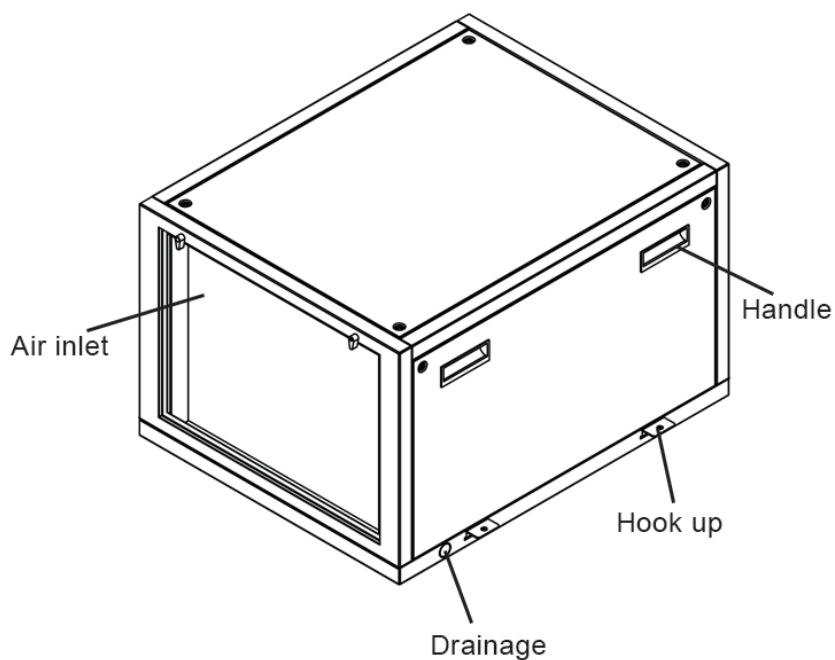

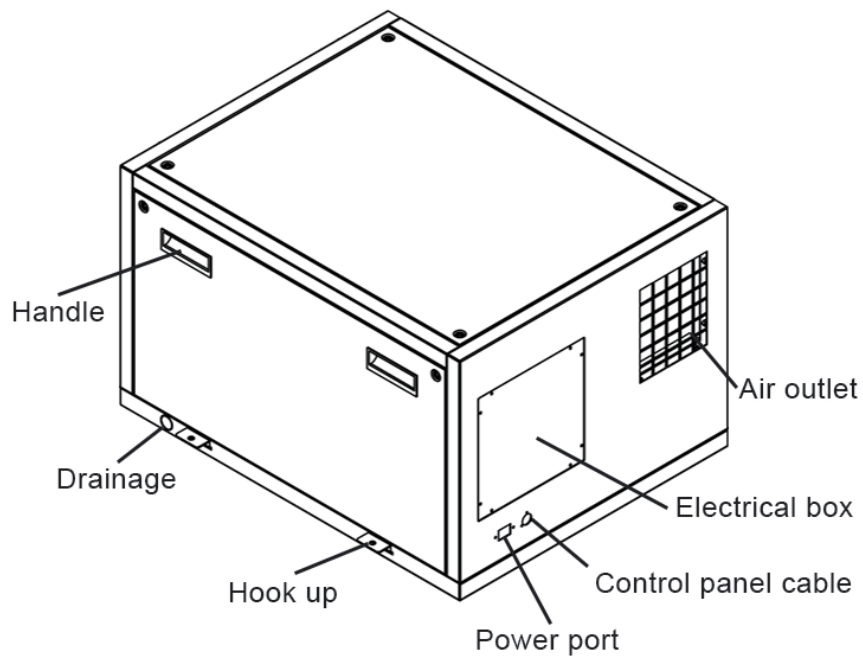

Sketch of the shell

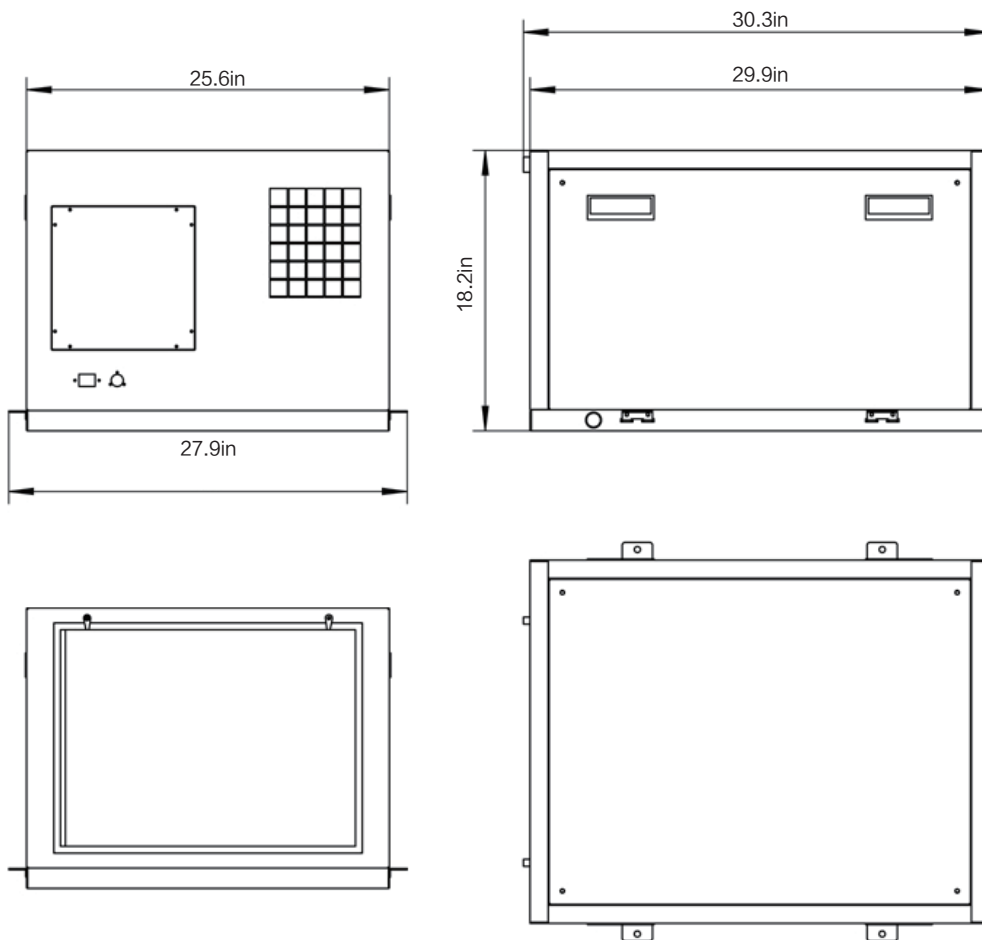

*Make sure suitable space to install the machine
 If the unit have to be installed close to wall, then try to keep machine air intake area and air outlet area more than 24in distance from the wall.

INSTALLATION SKETCH

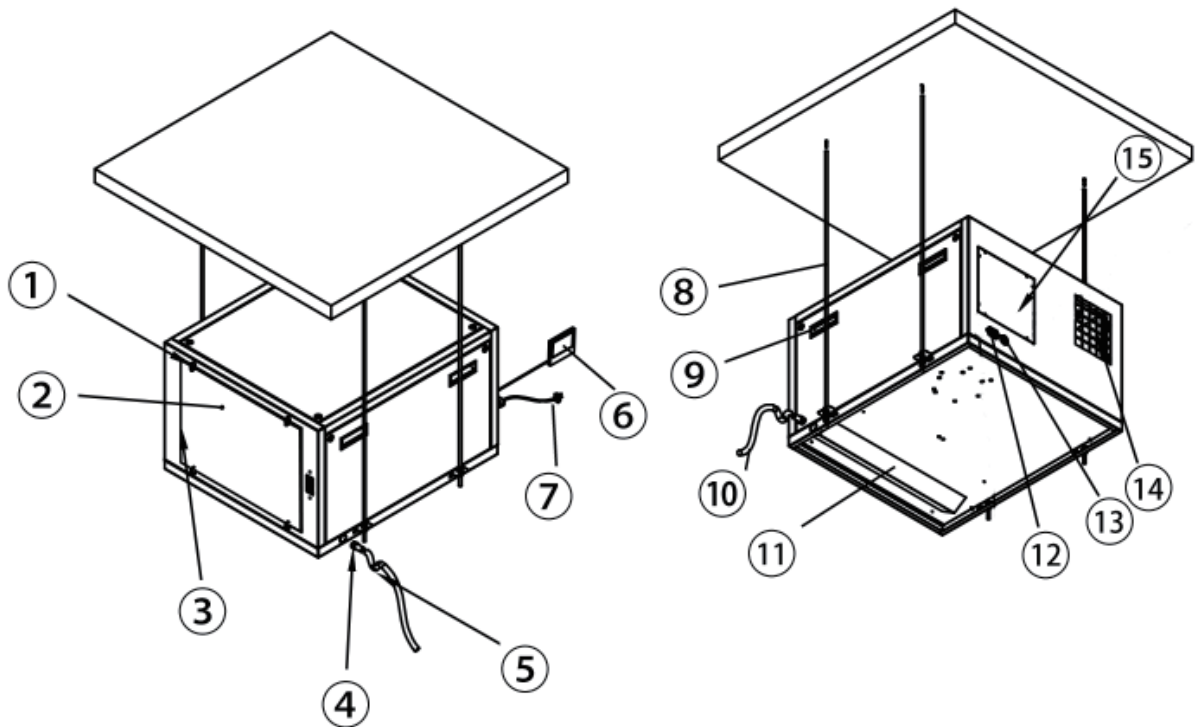

- ① Filter Buckle
- ② Washable air filter
- ③ Air intake area
- ④ Drainage port connector
- ⑤ Water storage elbow (clients prepare)
- ⑥ Controller panel
- ⑦ Controller wire
- ⑧ Hanging rod (clients prepare)
- ⑨ Carrying handle
- ⑩ Drainage soft pipe
- ⑪ Water channel
- ⑫ Power interface
- ⑬ Controller wire interface
- ⑭ Air outlet area
- ⑮ Electric box

⚠ Attention: Install the machine stably with screw suspender on the ceiling, and make sure installation in flat.

CONTROL PANEL

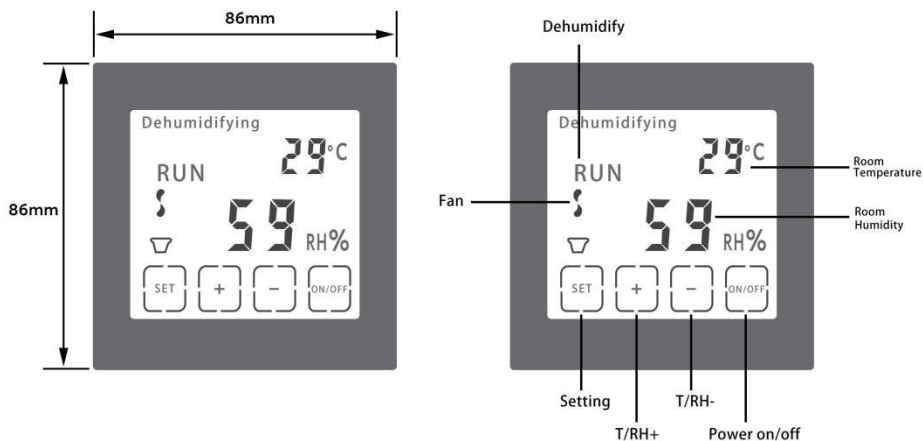

Operation

1. The screen turns on and displays ambient humidity and temperature when power is on the dehumidifier.
2. Press "Power on/off" button to start the dehumidifier.
 - Press "Setting" once to set target humidity.
 - Press "Setting" twice to set timed on hours.
 - Press "Setting" thrice to set timed off hours.
 - Press "Setting" quartic back to running display.
3. "Humi +" Press the key to set the humidity value up with 1%RH scale in running mode.
 - Press the key to set the hour up with 1 hour scale in timed on/off setting mode.
4. "Humi -" Press the key to set the humidity value down with 1%RH scale in running mode.
 - Press the key to set the hour down with 1 hour scale in timed on/off setting mode.
5. "Humidity display" Current ambient humidity display when in standby / dehumidifying mode.
 - Blinking when at humidity setting mode.
6. "RUN" Light on when dehumidifying mode and Blinking when in the 3 minutes delay protection mode.
7. "Defrosting indicator light" Blinking when the machine is automatic defrosting
8. "Timed on/off and clock display" Blinking when in timed on/off or clock setting mode
9. "Dehumidifying" Light on when dehumidifying mode and
 - Blinking when in the 3 minutes delay protection mode.

Functions

1. The machine goes into standby mode when connected to power supply (plug), LCD screen lights and displays current ambient humidity and temperature.
2. Press the "Power on/off" key to start the machine.
3. Humidity setting: press "+" or "-" key to adjust humidity you want, the dehumidifier will start working when the set humidity is 3% less than the current humidity, the dehumidifier will stop working when the set humidity is 3% more than the current humidity. Humidity setting range RH10%~95%.
4. Time set: press the "SET" key into timed on setting mode, "on" light blinking, press "+" or "-" to set hours up or down. Press the "SET" key again into timed off setting mode, "off" light blinking, then press "+" or "-" to set hours up or down. Press the "SET" key exit timed on/off setting mode. Please return hours to zero when you don't need the timed on/off function after power off, the machine has memory function when you power on.
5. After setting the timed on/off, if the machine is shutdown, it will run all the timed on/off setting; if the machine is running, it will run timed off setting only. Set the timed on/off time to 00 hours when you don't need the function.

PROTECTION FUNCTION

1. Automatic defrost protection function

The dehumidifier will defrost automatically when it frosts on a certain level on the evaporator, compressor shutdown. The dehumidifier will start automatically when defrosting is finished. We set the machine to defrost when ambient temperature is under 60°F.

2. Compressor delay start protection function

If you want to start the machine 3 minutes after shutdown dehumidifier, the compressor will start after 3 minutes for delay protection.

3. Error code

CODE	DESCRIPTION	SOLUTIONS
E1	Coil temperature sensor error	check the data wire or replace new sensor
E2	Room temperature humidity sensor error	check the data wire or replace new sensor
E6	Compressor pressure protection	fill enough r frigerant and check the leakage point

CAUTION IN USE

- Do not tilt the machine more than 45 ° in moving or installation to avoid damage to the compressor.
- Please try to seal environment better to increase the effect of dehumidifier
- Do not place the machine in the area which may come into contact with water or chemical.
- Do not use any relay, extension line or adapter to connect the power of machine.
- Do not place the machine next to the stove, heater and other equipment will dissipate heat, and area with direct sunlight or wind and rain.
- Do place the plug stably and clean the dust on power line.
- Do not damage or modify the power line, do not repair by yourself and disassemble or modify the machine.
- Do place the drainage tube smoothly for continuously drain.
- Please shutdown the machine and cut power when in malfunction.

COMMON FAULTS REMOVING

FAILURE PHENOMENON	CAUSE ANALYSIS	PROCESSING METHOD
The machine is not running	Power cut	Restore the power
	Power is not normal	Restore power
	Power plug is not plugged in	Put plug into the receptacle
	Fuse blowout	Replace the fuse
Poor dehumidification function	Filter Clogged	Clean the filter
	Air inlet and outlet blocked	Remove obstructions to make good ventilation
	Windows and doors is not closed	Close doors and windows and vents
	Refrigerant leakage	Contact for maintenance
Cannot reach suitable humidity level after long time running	Doors and windows are not closed	Close doors and windows and vents
	Vapour source existed in the room	Close vapour source
	Room too large	Provide right room size to buy correct machine and quantities
Noise abnormally	The machine placed not stably	Place the machine stably
	Filter Clogged	Clean the filter

1. When the malfunction can not be removed and recognized, please contact the supplier for maintenance service, do not attempt to disassemble the machine to repair without guide.
2. When the malfunction can not be removed and recognized, please contact the supplier for maintenance service, do not attempt to disassemble the machine to repair without guide.
3. Discharge hot air from outlet is a normal phenomenon.

MAINTENANCE OF MACHINE

Shutdown the machine and cut power before maintenance.

General maintenance

Wipe the body with soft cloth in daily use. Use a wet hard cloth to wipe dirty body, or use a soft cloth moistened with a little diluted neutral detergent.

Regular maintenance

Filter Cleaning: it will affect the dehumidifying effect or cause malfunction if accumulate dust on filter , it needs to be cleaned regularly, clean it at least once a month. Use dust catcher to remove dust or put filter into clean water to wash, then place filter back after cleaning.

P.S.

The filter cannot be put in sunlight directly or roasted to avoid distortion. The filter must be place before power up machine.

Long time of non-use

Cut the power or unplug power line to put it in dry and shady place. Do not put down the machine to avoid damage and malfunction.

Customer Support

TriCleanAir

972-656-9032

info@tricleanair.com

USING DRY CONTACTS (REMOTE CONTROL)

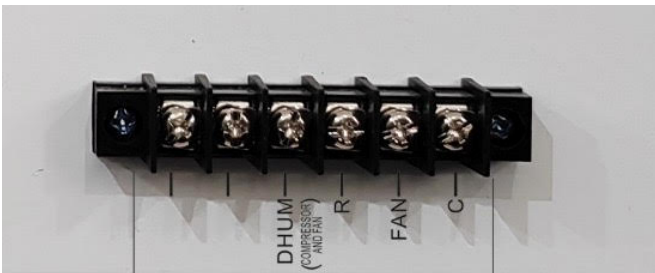

Tips:

Set Units On Board Controller to 99%

Jumper R to Fan (24/7 Fan Mode) or Use Remote Controller To Fan On

Recommend 20g or Larger Wire

R- Supplies 24VAC

DHUM- When Powered Will Activate Dehumidification Mode

FAN- When Powered Will Turn Fan On

ADDING DUCT WORK

Return Air: Cover the entire return of the unit using a plenum box with 16" duct no longer then 10'. Add a filter box inside your room.

Supply Air: Cover the supply using a plenum box with 14" no longer then 8' duct.

TECHNICAL PARAMETERS

Model no.	TCA-320D
Input Voltage	220-240V-60Hz
Rated input power	1.8 Kw
Rated input current	8.5 A
Air flow	750 CFM
Applying area	1200 - 2000 sqft
Refrigerant	R410a/0.95Kg
Nominal dehumidifying	320 PPD @ 80F/60%RH
Working temperature	40 - 100 F
Gross weight	160 lbs
Net Weight	120 lbs
Overall dimension	30*26*18.5 in







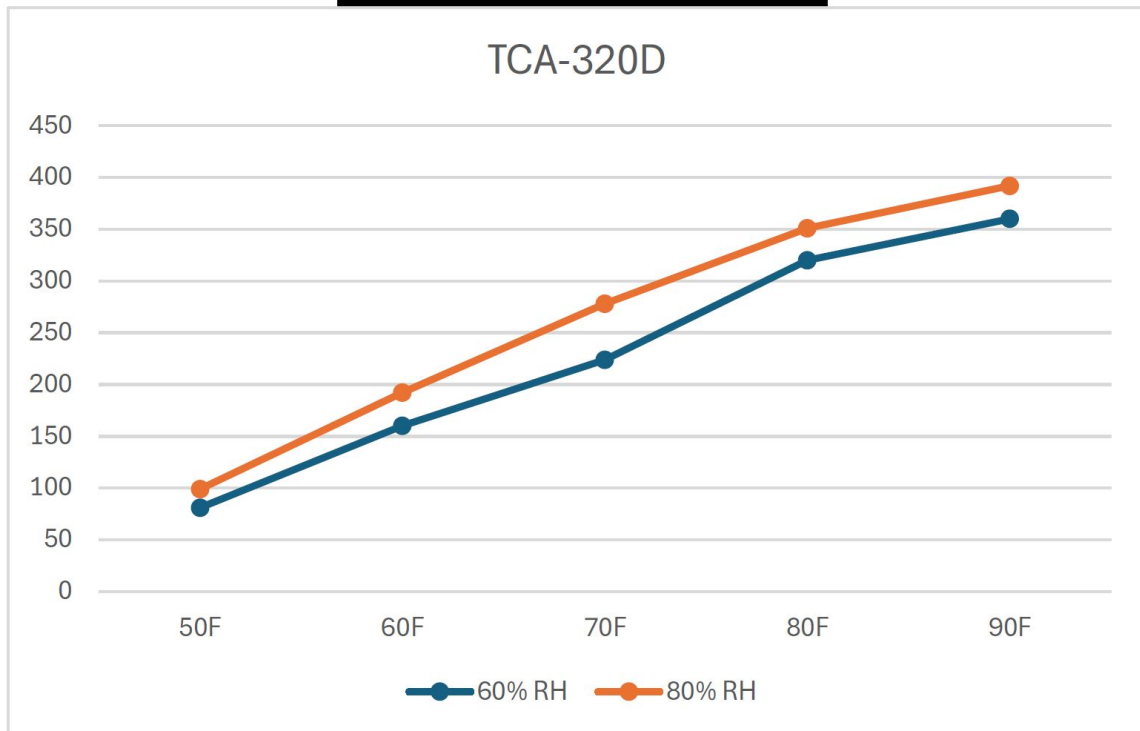



It will be not noticed additionally if any change of above parameters, please contact with supplier.

Performance

Temp	60% RH	80% RH
50F	81	99
60F	160	192
70F	224	278
80F	320	351
90F	360	392



What in the box

PICTURE	DESCRIPTION	QUANTITY
	User's Manual	1
	Dehumidifier	1
	Control Panel	1
	Power Line	1
	24 V Dry Contact	1
	Uneven Leg	4
	Cap Screw	8
	Surface Wire Box	1
	3/4" Water Pipe Connector	1
	Filter screen	1