

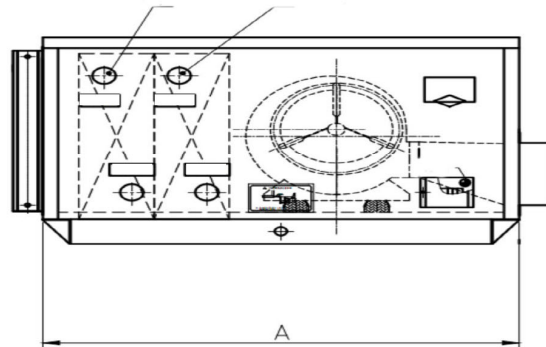

Unit Tag	Qty	Model No	Net Cooling	Nominal Voltage
TCA12TAHURH2083P	1	TCA12TAHURH2083P	12.00	208-3-60

Evaporator Data		Reheat Data		Physical Data		
Surface Area (sq.m)	239.40	Moisture Removal (ppd)	1536.00	Rigging Wt. (lb)	432	
EWT (°F)	44.00	Effeciency P/kWH	40.00	Operating Wt. (lb)	446	
Cooling Water Flow (gpm)	32.00	Hot Water Flow (gpm)	24.00	Water Connection (ND)	2	
Fan Data		Testing Conditions		Drain Pipe (ND)	1	
Qty	2	Ambient Temp.	80	Electrical Data		
Watts	800	Humidity (%)	60	FLA (amp)	7.7	
CFM	3530	A (in)	B (in)	C (in)	MCA (amp)	10
Static Pressure (Pa)	490	43	64	26		

Cooling Coil Heating Coil

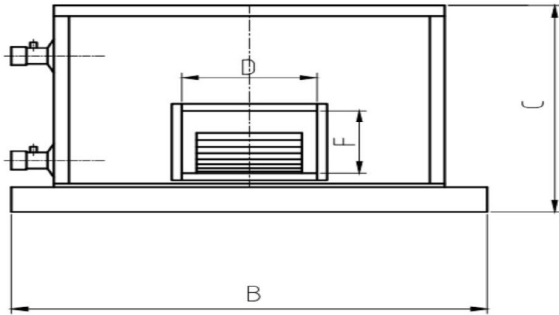

<https://tricleanair.com/techsheets/>