

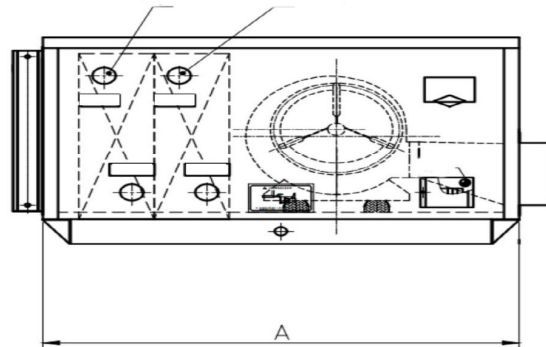

Unit Tag	Qty	Model No	Net Cooling	Nominal Voltage
TCA1TAHURH2403P	1	TCA1TAHURH2403P	1.00	240-3-60

Evaporator Data		Reheat Data		Physical Data		
Surface Area (sq.m)	22.70	Moisture Removal (ppd)	128.00	Rigging Wt. (lb)	165	
EWT (°F)	44.00	Effeciency P/kWH	21.30	Operating Wt. (lb)	169	
Cooling Water Flow (gpm)	3.10	Hot Water Flow (gpm)	2.30	Water Connection (ND)	1.5	
Fan Data		Testing Conditions		Drain Pipe (ND)	1	
Qty	1	Ambient Temp.	80	Electrical Data		
Watts	250	Humidity (%)	60	FLA (amp)	2	
CFM	750	A (in)	B (in)	C (in)	MCA (amp)	3
Static Pressure (Pa)	210	37	31	20		

Cooling Coil Heating Coil

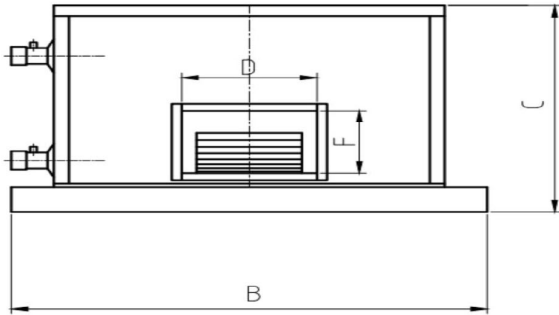

<https://tricleanair.com/techsheets/>