

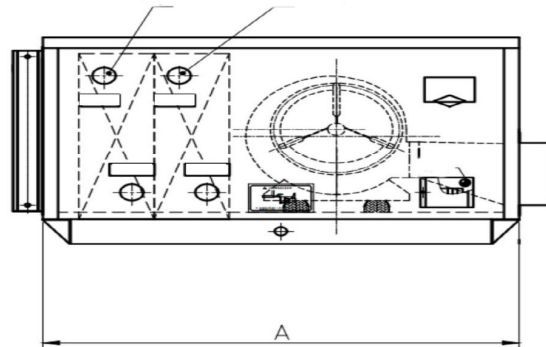

Unit Tag	Qty	Model No	Net Cooling	Nominal Voltage
TCA2TAHURH2403P	1	TCA2TAHURH2403P	2.00	240-3-60

Evaporator Data		Reheat Data		Physical Data		
Surface Area (sq.m)	34.10	Moisture Removal (ppd)	256.00	Rigging Wt. (lb)	175	
EWT (°F)	44.00	Effieicntcy P/kWH	42.67	Operating Wt. (lb)	179	
Cooling Water Flow (gpm)	4.50	Hot Water Flow (gpm)	3.70	Water Connection (ND)	1.5	
Fan Data		Testing Conditions		Drain Pipe (ND)	1	
Qty	1	Ambient Temp.	80	Electrical Data		
Watts	250	Humidity (%)	60	FLA (amp)	2	
CFM	1000	A (in)	B (in)	C (in)	MCA (amp)	3
Static Pressure (Pa)	210	37	31	20		

Cooling Coil Heating Coil

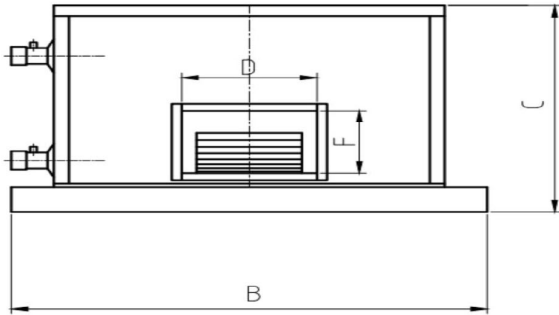

<https://tricleanair.com/techsheets/>